

INSTALLATION & OPERATIONS MANUAL

MOBILE ROOM AIR CONDITIONER

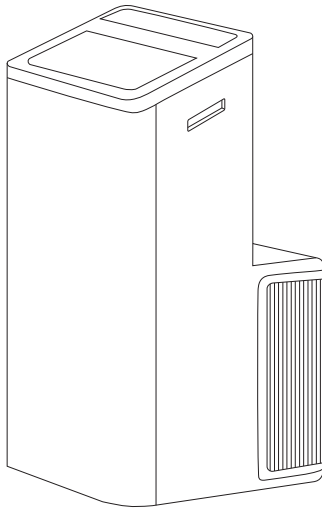

PQA12C
PQF12CH

- ※ Please read this owner's manual carefully and thoroughly before operating the unit!
- ※ Take care of this manual for future reference.

CONTENTS

Warning	1
Safety Precaution	2
Parts Description	5
Control Panel	6
Operation	8
Accessories	9
Notice of installation	10
Installation	12
Maintenance	17
Troubleshooting	18
Maintenance Notice	19

Note: All the illustrations in this manual are for explanation purpose only. Your air conditioner may be slightly different. The actual shape shall prevail. They are subject to change without notice for future improvement.

WARNING





WARNING: This air conditioner uses R290 flammable refrigerant.

Notes: Air conditioner with R290 refrigerant, if roughly treated, may cause serious harm to the human body or surrounding things.

* The room space for the installation, use, repair and storage of this air conditioner shall be in accordance with the following table:

Refrigerant Content	Room Area	Refrigerant Content	Room Area
$m \leq 152g$	$\geq 4m^2$	$185 < m \leq 250g$	$\geq 12m^2$
$152 < m \leq 185g$	$\geq 9m^2$	$250 < m \leq 304g$	$\geq 15m^2$

- * Do not use any methods to speed up defrost or to clean frosty parts except for particular recommended by manufacturer.
- * Not pierce or burn air conditioner, and check the refrigerant pipeline whether be damaged. The air conditioner should be stored in a room without lasting fire source, for example, open flame, burning gas appliance, working electric heater and so on.
- * Notice that the refrigerant may be tasteless.
- * The storage of air conditioner should be able to prevent mechanical damage caused by accident.
- * Maintenance or repair of air conditioners using R290 refrigerant must be carried out after security check to minimize risk of incidents.
- * Please read the instruction carefully before installing, using and maintaining.

Symbol	Note	Explanation
	WARNING	This symbol shows that this appliance uses a flammable refrigerant. If the refrigerant is leaked and exposed to an external ignition source, there is a risk of fire.
	CAUTION	This symbol shows that the operation manual should be read carefully.
	CAUTION	This symbol shows that a service personnel should be handling this equipment with reference to the installation manual.
	CAUTION	This symbol shows that information is available such as the operating manual or installation manual.

Safety Precautions

Incorrect installation or operation by not following these instructions may cause harm or damage to people, properties, etc.

The seriousness is classified by the following indications:

WARNING

This symbol indicates the possibility of death or serious injury.

CAUTION

This symbol indicates the possibility of injury or damage to properties.

WARNING

- ❶ This appliance can be used by children aged from 8 years and above and persons with reduced physical, sensory or mental capabilities or lack of experience and knowledge if they have been given supervision or instruction concerning use of the appliance in a safe way and understand the hazards involved. Children shall not play with the appliance. Cleaning and user maintenance shall not be made by children without supervision.
(Only for the AC with CE-MARKING)
- ❷ This appliance is not intended for use by persons (including children) with reduced physical, sensory or mental capabilities, or lack of experience and knowledge, unless they have been given supervision or instruction concerning use of the appliance by a person responsible for their safety. Children should be supervised to ensure that they do not play with the appliance.
(Except for the AC with CE-MARKING)
- ❸ This unit is designed for indoor use only.
- ❹ The air conditioner must be grounded. Incomplete grounding may result in electric shocks.
- ❺ Do not connect the earth wire to the gas pipeline, water pipeline, lightning rod, or telephone earth wire.
- ❻ After installment, earth leakage examination must be carried on through electrifying.

Safety Precautions

- ❶ An earth leakage breaker with rated capacity must be installed to avoid possible electric shocks.
- ❷ Don't install air conditioner in a place where there is flammable gas or liquid. It may cause fire or explosion.
- ❸ If the power supply cord is damaged, it must be replaced by the manufacture or its service agent or a similar qualified person.
- ❹ The specification of the fuse are printed on the circuit board, such as: AC 250V/5A.
- ❺ Don't put hands or any objects into the air inlets or outlets. This may cause personal injury or damage to the unit.
- ❻ Don't touch the swinging wind vanes. It may damp your finger and damage the driving parts of the wind vanes.
- ❼ Don't attempt to repair the air conditioner by yourself. You may be hurt or cause further malfunctions.
- ❽ In lighting storm weather, please cut off the primary power supply switch in order to prevent the machine from damage.
- ❾ Don't use liquid or corrosive detergent to clean the appliance and don't splash water or other liquid onto it, otherwise, it may damage the plastic components, even cause electric shock.
- ❿ Don't operate the unit in a wet room such as the bath room or laundry rooms.
- ⓫ Don't touch the unit with wet or damp hands or when barefoot.
- ⓬ Don't pull the unit by the cord.
- ⓭ Don't remove any part of the unit unless instructed by an authorized technician.
- ⓮ Don't move the unit, unless the power has been cut off and the power cord is tied to the bending and winding column.
- ⓯ Don't operate the unit with a damaged plug or a loose socket.
- ⓰ Ducts connected to an appliance shall not contain an ignition source.

Safety Precautions

WARNING

Failure to follow the below precaution could result in electrical shock, fire or personal injury.

1. The plug must be plugged into an outlet that is properly installed and grounded.
2. Do not use an extension cord or plug adaptor with this unit.

CAUTION

- Don't apply the cold air to the body for a long time. It will deteriorate your physical conditions and cause health problems.
- Don't block air inlet or air outlet, otherwise, the cooling / heating capacity will be weakened, even cause system stop operating.
- Close the windows and doors, otherwise, the cooling / heating capacity will be weakened.
- If the air filter is very dirty, the cooling / heating capacity will be weakened. Please clean the air filter regularly.

WEEE Warning

Meaning of crossed out wheeled dustbin:
Do not dispose of electrical appliances as unsorted municipal waste, use separate collection facilities.

Contact you local government for information regarding the collection systems available. If electrical appliances are disposed of in landfills or dumps, hazardous substances can leak into the groundwater and get into the food chain, damaging your health and well-being. When replacing old appliances with new ones, the retailer is legally obligated to take back your old appliance for disposals at least free of charge.

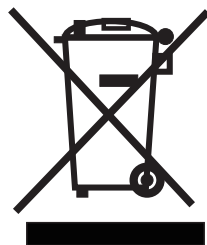

Parts Description

FRONT VIEW

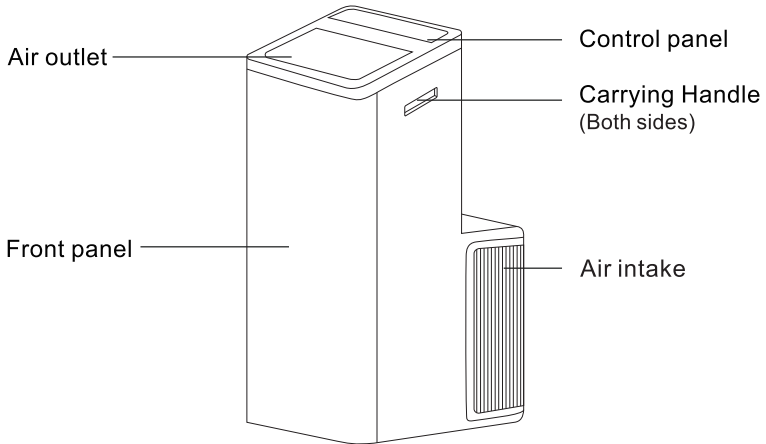

REAR VIEW

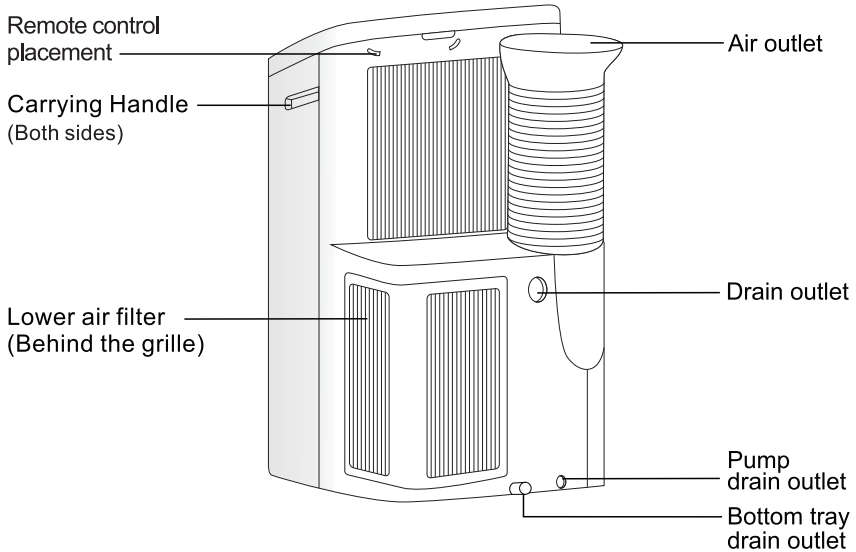

NOTE:

- * The descriptions in this user manual are text and figures may have slightly difference to the promotion information and actual appliance. Please refer to the real appliance purchased, Thank you.
- * The working temperature range of the air conditioner is 16~35°C (60~95°F) under cooling mode; 5~27°C (41~80°F) under heating mode.



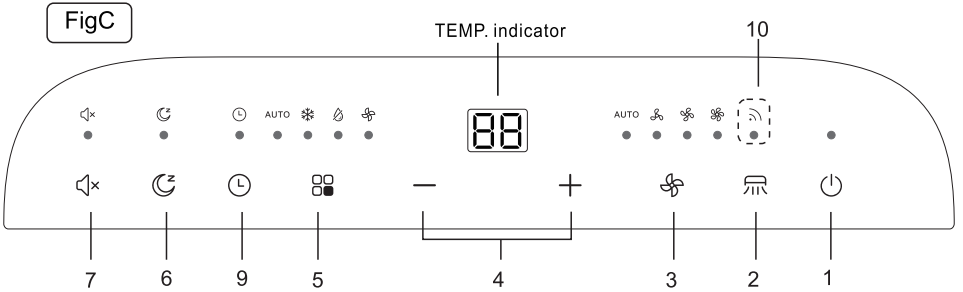
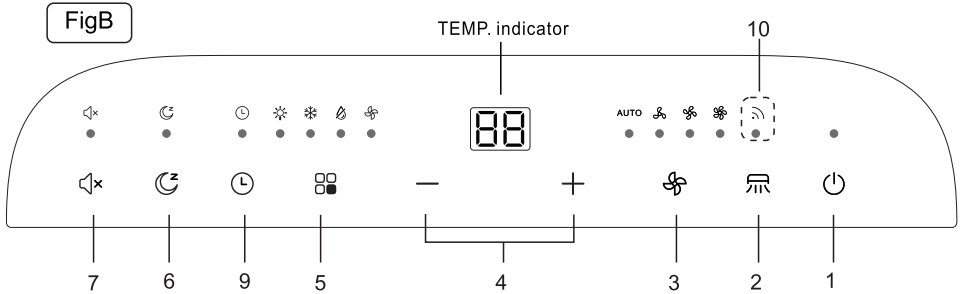
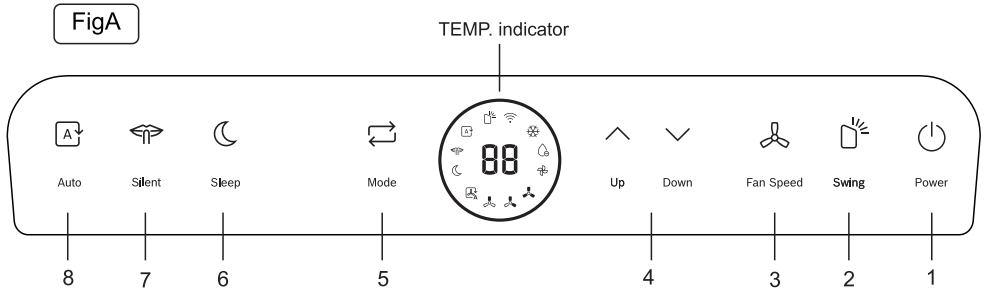

Control Panel

There are three types of control panels, FigA, FigB and FigC, the actual shape shall prevail.



Control Panel

Function buttons

1.  **button** — Press this button to make the unit run or stop.
2.  /  **button** — Press this button, the swing indicator light will illuminate.
3.  /  **button** — Press this button, you can select the fan speed as follows:

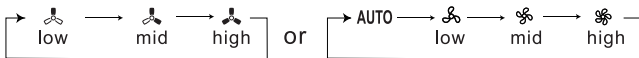





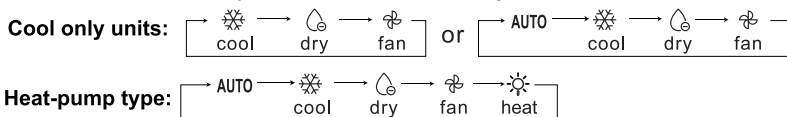

The fan speed indicator light illuminates under the different fan speed.

4.  **button** —
 - a. Each time the (∇ /-) or (\wedge /+) button is pressed, the setting temperature will increase or decrease by 1°C (1°F). The setting temperature ranges from 16°C (60°F) ~ 32°C (90°F).
 - b. By pressing both the (∇ /-) and (\wedge /+) button at the same time ($\geq 3s$), the display will toggle between Celsius and Fahrenheit.

5.  /  **button** — Press this button, you can select the running mode as follows:



The mode indicator light illuminates under the different mode.

6.  /  **button** — Press this button to enter sleep mode, which the unit will exit after 8 hours of continuous operation and restore to the previous status.
Note: The SLEEP function can not be activated in fan and dry mode.
7.  **button** — In this mode the appliance will run on the lowest noise level while automatically adjusting and controlling the cooling performance based on the temperature selected and the environmental conditions.
 **button** — By activating this function in the cooling mode of the air conditioner, the noise of the appliance is further reduced. To activate it, press the button.
8.  **button** — Press this button, The appliance automatically chooses the best fan speed based on the temperature selected and the environmental conditions.
9.  **button** —
 - a. Press the " \odot " button, the timer indicator light illuminates.
 - b. Press ∇ /- or \wedge /+ button to select the desired time.
 - c. After setting time 5 seconds without other operation, the timing function will be initiated automatically. If you press the timer button, there are no operation within 5 seconds or setting time is 0, the timing function will be cancelled automatically.
 - d. When the timing function is initiated, the unit displays the remaining time by press the "timer" button once and cancel the timing function by press it again.

Note: With the unit on, press this button to set off timer.
With the unit off, press this button to set on timer.

10. WI-FI Function

Press and hold the "" button for 5 seconds, the WI-FI turn on for matching.

After the wifi connection is successful, the indicator lights up and the previous display status is restored.

Note: Please refer to the WiFi manual for detailed instructions.

If the control panel does not have this "" symbol, the WI-FI function is unavailable.

TEMP. indicator

- * In cooling or heating mode, when (∨/-) or (∧/+) button is pressed, the setting temperature is displayed and be adjusted.
- * 1.In auto, cool and heat mode, TEMP.indicator display is setting temperature.
2.In dry and fan mode, TEMP.indicator display is room temperature.

WARNING

Failure to follow the below precaution could result in electrical shock, fire , explosion or personal injury.

- 1. The plug must be plugged into an individual socket that is properly installed and grounded.**
- 2. Do not use an extension cord or plug adaptor with this unit.**

Before starting the unit

1. Select a suitable location, make sure the unit is near to an electrical outlet.
2. Install the flexible exhaust hose and the adjustable window slider kit.
3. Plug the unit into a right outlet.

Heating operation mode (Cool only unit has no heating function)

1. Press the MODE button in a sequence until the heat indicator is lighted.
2. Press the (∨/-)and (∧/+)button to setting your desired setting temperature.
3. Press FAN button to select the fan speed.

Cooling operation mode

1. Press the MODE button in a sequence until the cool indicator is lighted.
2. Press the (∨/-)and (∧/-) button to set your desired setting temperature.
3. Press FAN button to select the fan speed.

Drying operation mode

1. Press the MODE button in a sequence until the dry indicator is lighted.
2. The fan will run at a fixed speed at this operation mode.
3. Close windows and doors for the best dehumidifying effect.

Note: The setting temperature and fan speed can not be adjusted.

Fan operation mode

1. Press MODE button in a sequence until the fan indicator is lighted.
2. Press the FAN button to select the fan speed.







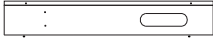

Note: The setting temperature can not be adjusted.

Auto-restart Function

If power to the unit is interrupted, the unit will restart itself in its last used mode / settings once power is restored. The compressor will restart after 3 minutes.

- 1.Set: Press the sleep button 10 times within 5 seconds, buzzer sounds 4 times.
- 2.Cancel: Press the sleep button 10 times within 5 seconds, buzzer sounds 2 times.

Accessories

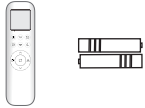
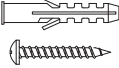
Parts	Parts name	Quantity
	Window Slider Kit(#)	1pc
	Type A Screws(#)	2pc
	Type B Screws(#)	6pc
	Security bracket(#)	1pc
	Type A foam seal(adhesive)(#)	2pc
	Type B foam seal(non-adhesive)(#)	1pc
	Adaptor B(round mouth)(#) , Wall exhaust Adaptor(#)	1set
	Drain hose	1pc
	Remote controller and Battery	1pc
	Expansion screw sleeve(#), Type C Screws(#)	4pc 4pc
NOTE: Optional parts (#), some models without.		

NOTE:

All the illustrations in this manual are for explanation purpose only. Your air conditioner may be slightly different. The actual shape shall prevail. They are subject to change without notice for future improvement.

Mobile air-conditioner air louver notes:

1. With automatic wind sweep function models, the air louver opening angle can not be less than automatically wind smallest outlet angle when use it.
2. No automatic wind sweep function models, air louver minimum opening angle: from air louver closed state breaking up 5 grid. air louver opening angle can not be less than the minimum open angle when use it.

Notice of Installation

Unpacking Inspection

- Open the box and check unit in area with good ventilation (open the door and window) and without ignition source.
Note: Operators are required to wear anti-static devices.
- It is necessary to check by professional whether there is refrigerant leakage before opening the box ; stop installing the air conditioner if leakage is found.
- The fire prevention equipment and anti-static precautions shall be prepared well before checking. Then check the refrigerant pipeline to see if there is any collision traces, and whether the outlook is good.

Safety Principles for Installing Air Conditioner

- Fire prevention device shall be prepared before installation.
- Keep installing site ventilated.(open the door and window).
- Ignition source, smoking and calling is not allowed to exist in area where R290 refrigerant located.
- Anti-static precautions in necessary for installing air conditioner, e.g. wear pure cotton clothes and gloves.
- Keep leak detector in working state during the installation.
- If R290 refrigerant leakage occurs during the installation, you shall immediately detect the concentration in indoor environment until it reaches a safe level. If refrigerant leakage affects the performance of the unit, please immediately stop the operation, and the unit must be vacuumed firstly and be returned to the maintenance station for processing.
- Keep electric appliance, power switch, plug, socket, high temperature heat source and high static away from the area underneath sidelines of unit.
- The unit shall be installed in an accessible location to installation and maintenance, without obstacles that may block air inlets or outlets of units, and shall keep away from heat source, inflammable or explosive conditions.

Notice of Installation

Requirements For Installation Position

- Avoid places of inflammable or explosive gas leakage or where there are strongly aggressive gases.
- Avoid places subject to strong artificial electric/magnetic fields.
- Avoid places subject to noise and resonance.
- Avoid severe natural conditions (e.g. heavy lampblack, strong sandy wind, direct sunshine or high temperature heat sources).
- Avoid places within the reach of children.
- Select where it is easy to perform service and repair and where the ventilation good.

Installation environment inspection

- Check nameplate of unit to make sure whether the refrigerant is R290.
- Check the floor space of the room. The space shall not be less than usable space(12m²) in the specification. The unit shall be installed at a well-ventilated place.
- Check the surrounding environment of installation site: R290 shall not be installed in the enclosed reserved space of a building.

ATTENTION

If the equipment emissions cannot meet the technical requirement of IEC 61000-3-3, following attention should be take care.

Attention: This appliance can be connected only to a supply with system impedance no more than Z_{max} . In case necessary, please consult your supply authority for system impedance information.

Product Type	Z_{max}
AM-09B5A4/QBR2-C1	0.371

Guide of customer

- The customer should have a qualified power supply coincident with that printed on the tag of the air conditioner.
- Must use dedicated and efficient grounding outlet matching with the plug of the air conditioner.
- The appliance should be installed in accordance with national wiring regulation.
- The plug should be easily accessible after installation.

Select a best location

1. Install the mobile air conditioner in a flat and spacious location where the air outlets will not be obstructed.
2. It is recommended that the air conditioner keep a distance of 50cm (19.7in) from the wall or other obstacles to achieve the best use effect.
3. The gradient can't be more than 10 degrees with the horizontal plane, while placing and using the unit.
Uneven ground may cause additional noise or vibration, or lead to damage to the unit.

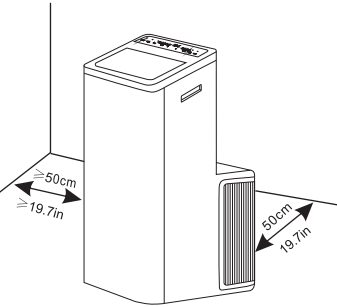

- Note:** 1. The air conditioner shall not be used in the laundry.
2. The plug shall be accessible after the unit is positioned.

Duct mount instruction

- In cooling, heating and drying mode, the exhaust duct needs to be installed while in fan mode, the exhaust duct is not needed.
- According to the actual needs, the exhaust duct can be moderately compressed and tensed, but cannot be arbitrarily stretched and bent.
- The exhaust duct can be connected with Windows or installed into the wall.
With the actual needs, you can make the installation with accessories of the unit.

1. Install the adaptor A and adaptor B onto the exhaust duct.
2. Connect the exhaust duct to the Air outlet connector on back of the unit.
Press the exhaust duct down and hear "click" to complete the installation.

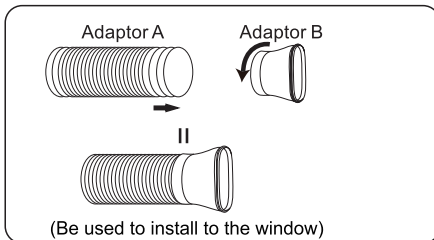

Step1

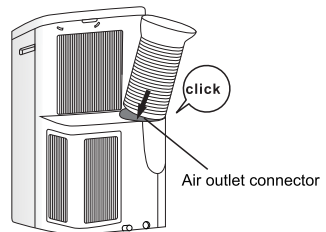

Step2

Installation

Install the Window Slider Kit

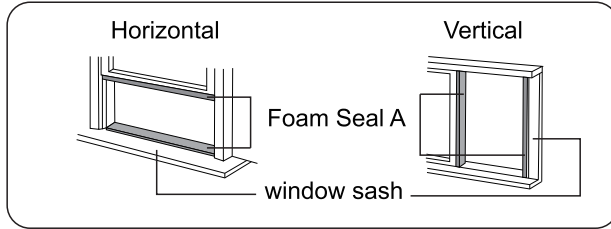

1. Cut the foam seal(adhesive type) to the proper length and attach it to the window sash.

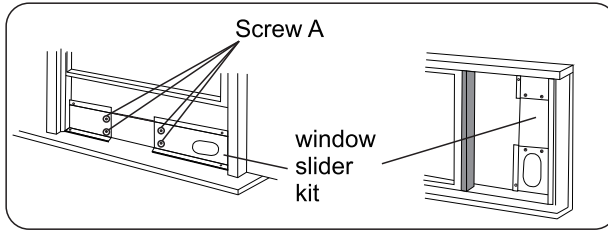

2. Attach the window slider kit to the window sash. Adjust the length of the Window Slider Kit: Loose the screw A to adjust the length of the Window Slider Kit, then tight the screw when the length is suitable.

Note: the length of the Window Slider Kit is 47cm to 130cm.

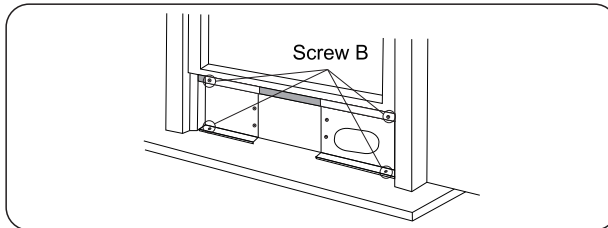

3. Carefully lower the window. Secure the vent panel in place with 4 type B screws, plus one screw for each extension.

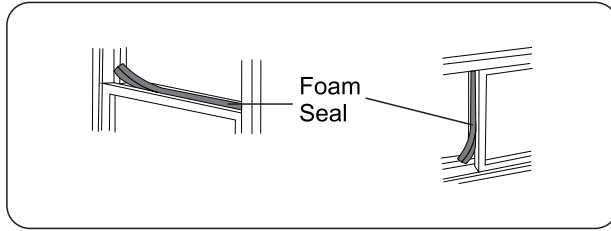

4. Cut the foam seal B (non-adhesive) to the window width. Stuff the foam seal B between the glass and the window to prevent air and insects from getting into room.

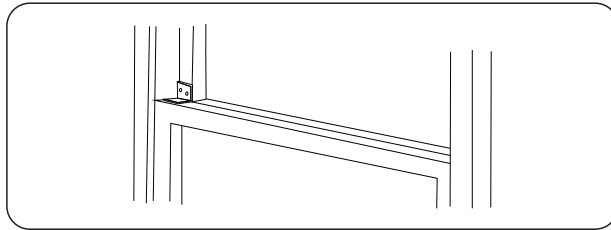

5. Install the security bracket with a type B screw, as shown.

Install the exhaust duct into the window

Remove the unit with the packed exhaust duct next to the window, and then connect the adaptor B (flat mouth) of the exhaust duct with the window. (Fig.E)

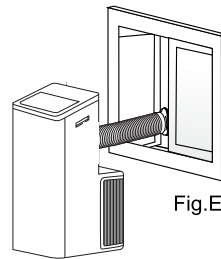

Installation

Install the exhaust duct into the wall

1. Prepare a hole in the wall. Install the wall exhaust adaptor onto the wall by using 4 expansion screw sleeve and type C screws, be sure to fix thoroughly.
2. Connect the exhaust duct to wall exhaust adaptor.(Fig.G)

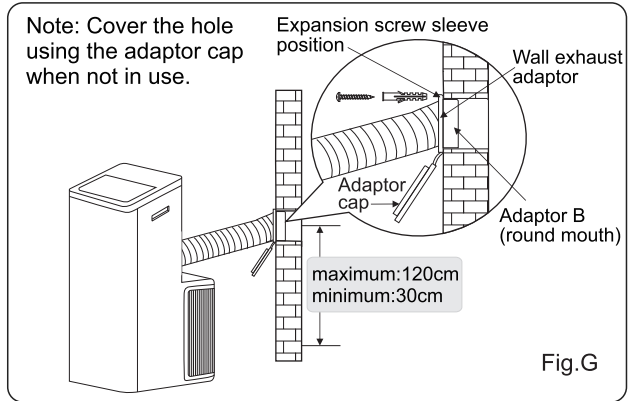

Note: 1.The duct can be compressed to 270mm minimum and extended to 1500mm maximum. It is better to keep the duct length to a minimum length.
2.Stretching or bending the duct excessively will affect the cooling efficiency.
(As the following fig. Shows)

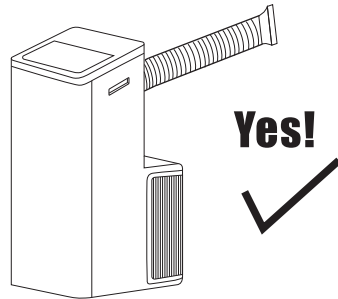
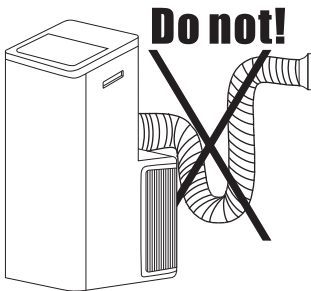

Without installation

If the unit does not have the window slider kit and wall exhaust, and the Adaptor B is like this ,as shown in Fig H. You can open the window slightly and position as shown in Fig I.

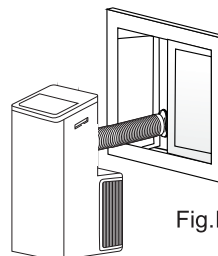
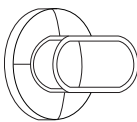

Water drainage

- * During dehumidifying mode, remove the upper drain plug from the back of the unit. Attach the drain hose to the hole. Place the other end of the hose in the drainage way or other drain areas .

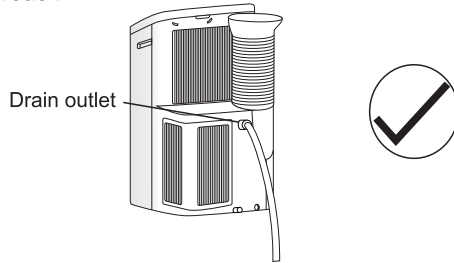

- * If the unit you bought has the pump drain outlet, as shown below, please drain in this way :

Remove the pump drain plug from the back of the unit, attach the drain hose to the hole. Place the other end of the hose in the drainage way or other drain areas.

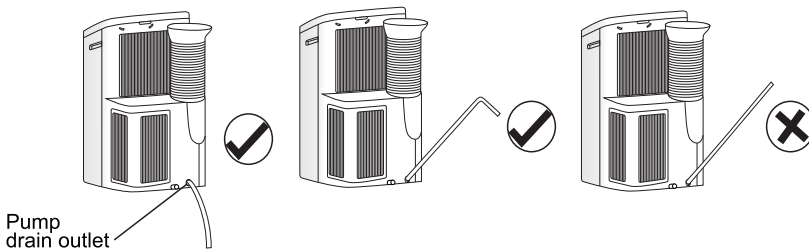

Note: Make sure the hose is secure and there are no leaks. Direct the hose toward the drain, making sure that there are no kinks that will stop the water flowing. Place the end of the hose into the drain and make sure the end of the hose is down to let the water flow smoothly. Do never let it up.

When the water level of the bottom tray reaches predetermined level, the digital display area shows "FL".

Carefully move the unit to a drain location, remove the bottom drain plug and let the water drain away. Reinstall the bottom drain plug and restart the machine until the "FL" symbol disappears. If the error repeats, call for service.

NOTE: Be sure to reinstall the bottom drain plug before using the unit.

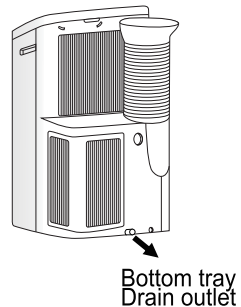

Maintenance

WARNING

- ※ Before the cleaning of the air conditioner, it must be shut down and the electricity must be cut off for more than 5 minutes, otherwise there might be the risk of electric shocks.
- ※ Do not use gasoline, benzene, thinner or any other chemicals, or any liquid insecticide on the air conditioner, as these substances may cause flaking off of the paint, cracking or deformation of plastic parts .
- ※ Never attempt to clean the unit by pouring water directly over any of the surface areas, as this will cause deterioration of electrical components and wiring insulation.

Clean the unit

When the unit is contaminated, clean it gently with a wrung towel using tepid water below 40°C (104°F).



Clean the Air Filter

1. Take out the upper air filter and the lower air filter .

Upper air filter: please refer to Fig. 1 first pull the filter outwards, when the air filter is loose, pull it upward.

Low air filter: unscrew one screw on the outer frame, tear down the outer frame, remove the filter from the outer frame.

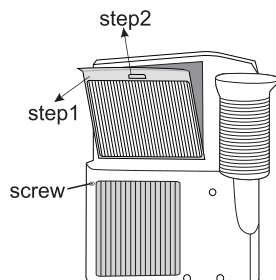
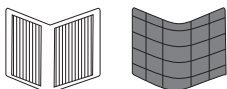

Fig.1

2. Clean the air filter

Use a vacuum cleaner or water to rinse filter, and if the filter is very dirty (for example, with greasy dirt), clean it with warm water (below 40°C (104°F)) with mild detergent dissolved in, and then put the filter in the shade to dry in the air.



3. Reinstall the dried filter in reverse order of removal. Put the filter cover back to its place.

Note:

If you don't use the unit for a long time, please pull out the rubber plug to drain the inside water out referring to right figure.

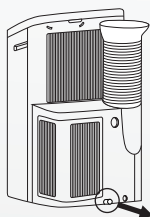

To save the cost of a service call, please try the suggestions below to see if you can solve your problem without outside help.

Air Condition Will Not Operate

Causes	Solutions
<ul style="list-style-type: none"> ● The power switch is released. ● Power supply failure. ● The fuse is burnt. ● It doesn't reach the setting time for starting up. 	<ul style="list-style-type: none"> ■ Switch on the power. ■ Wait for the recovery of power supply. ■ Replace the fuse by professional . ■ Wait or reset the original setting.

Unit Doesn't Start When Pressing ON/OFF Button

Causes	Solutions
<ul style="list-style-type: none"> ● It is not four minutes after switch off. ● Room temperature is lower than the setting temperature under cooling mode or higher than setting temperature under heating mode. 	<ul style="list-style-type: none"> ■ Wait four minutes. ■ Reset the setting temperature.

The Wind Blowing Out, But The Cooling / Heating Effect Is Bad

Causes	Solutions
<ul style="list-style-type: none"> ● Mistakes in temperature setting. ● The air filter is blocked by dust. ● The air inlet or outlet of machine is blocked. ● Turn the air conditioner on in very hot room. ● Cooling capacity is insufficient. ● The doors or windows are open. 	<ul style="list-style-type: none"> ■ Set a proper temperature, setting temperature should be lower than ambient temperature. ■ Clean the air filter. ■ Remove the obstruction. ■ Allow additional time to remove stored heat from walls ,ceiling, floor and furniture. ■ Reconfirm the required cooling / heating capacity with your dealer. ■ Close the doors and windows.

Noise or vibration

Causes	Solutions
<ul style="list-style-type: none"> ●The ground is not level or not flat enough. 	<ul style="list-style-type: none"> ■ Place the unit on a flat, level ground if possible.

Maintenance Notice

WARNING

For maintenance or scrap, please contact authorized service centers.

Maintenance by unqualified person may cause dangers.

Feed air conditioner with R290 refrigerant, and maintain the air conditioner in strictly accordance with manufacturer's requirements. The chapter is mainly focused on special maintenance requirements for appliance with R290 refrigerant. Ask repairer to read after-sales technical service handbook for detailed information.

Qualification requirements of maintenance personnel

- 1.Special training additional to usual refrigerating equipment repair procedures is required when equipment with flammable refrigerants is affected. In many countries, this training is carried out by national training organisations that are accredited to teach the relevant national competency standards that may be set in legislation. The achieved competence should be documented by a certificate.
- 2.The maintenance and repair of the air conditioner must be conducted according to the method recommended by the manufacturer. If other professionals are needed to help maintain and repair the equipment, it should be conducted under the supervision of individuals who have the qualification to repair AC equipped with flammable refrigerant.

Inspection of the Site

Safety inspection must be taken before maintaining equipment with R290 refrigerant to make sure the risk of fire is minimized. Check whether the place is well ventilated, whether anti-static and fire prevention equipment is perfect.

While maintaining the refrigeration system, observe the following precautions before operating the system.

Operating Procedures

- 1.General work area:

All maintenance staff and others working in the local area shall be instructed on the nature of work being carried out. Work in confined spaces shall be avoided. The area around the workspace shall be sectioned off. Ensure that the conditions within the area have been made safe by control of flammable material.

2. Checking for presence of refrigerant:

The area shall be checked with an appropriate refrigerant detector prior to and during work, to ensure the technician is aware of potentially toxic or flammable atmospheres. Ensure that the leak detection equipment being used is suitable for use with all applicable refrigerants, i.e.non-sparking, adequately sealed or intrinsically safe.

- 3.Presence of fire extinguisher:

If any hot work is to be conducted on the refrigeration equipment or any associated parts, appropriate fire extinguishing equipment shall be available to hand. Have a dry powder or CO₂ fire extinguisher adjacent to the charging area.

4.No ignition sources:

No person carrying out work in relation to a refrigeration system which involves exposing any pipe work shall use any sources of ignition in such a manner that it may lead to the risk of fire or explosion. All possible ignition sources, including cigarette smoking, should be kept sufficiently far away from the site of installation, repairing, removing and disposal, during which refrigerant can possibly be released to the surrounding space. Prior to work taking place, the area around the equipment is to be surveyed to make sure that there are no flammable hazards or ignition risks.

'No Smoking' signs shall be displayed.

5.Ventilated Area(open the door and window):

Ensure that the area is in the open or that it is adequately ventilated before breaking into the system or conducting any hot work. A degree of ventilation shall continue during the period that the work is carried out. The ventilation should safely disperse any released refrigerant and preferably expel it externally into the atmosphere.

6.Checks to the refrigeration equipment:

Where electrical components are being changed, they shall be fit for the purpose and to the correct specification. At all times the manufacturer's maintenance and service guidelines shall be followed. If in doubt, consult the manufacturer's technical department for assistance. The following checks shall be applied to installations using flammable refrigerants:

- The charge size is in accordance with the room size within which the refrigerant containing parts are installed.
- The ventilation machinery and outlets are operating adequately and are not obstructed.
- If an indirect refrigerating circuit is being used, the secondary circuit shall be checked for the presence of refrigerant.
- Refrigeration pipe or components are installed in a position where they are unlikely to be exposed to any substance which may corrode refrigerant containing components, unless the components are constructed of materials which are inherently resistant to being corroded or are suitably protected against being so corroded.

7.Checks to electrical devices:

Repair and maintenance to electrical components shall include initial safety checks and component inspection procedures. If a fault exists that could compromise safety, then no electrical supply shall be connected to the circuit until it is satisfactorily dealt with. If the fault cannot be corrected immediately but it is necessary to continue operation, an adequate temporary solution shall be used. This shall be reported to the owner of the equipment so all parties are advised.

Initial safety checks shall include:

- That capacitors are discharged: this shall be done in a safe manner to avoid possibility of sparking.
- That no live electrical components and wiring are exposed while charging, recovering or purging the system.
- Keep continuity of earthing.

Maintenance Notice

Inspection of Cable

Check the cable for wear, corrosion, overvoltage, vibration and check if there are sharp edges and other adverse effects in the surrounding environment. During the inspection, the impact of aging or the continuous vibration of the compressor and the fan on it should be taken into consideration.

Leakage check of R290 refrigerant

Note: Check the leakage of the refrigerant in an environment where there is no potential ignition source. No halogen probe (or any other detector that uses an open flame) should be used.

Leak detection method:

For systems with refrigerant R290, electronic leak detection instrument is available to detect and leak detection should not be conducted in environment with refrigerant. Make sure the leak detector will not become a potential source of ignition, and is applicable to the measured refrigerant. Leak detector shall be set for the minimum ignitable fuel concentration (percentage) of the refrigerant. Calibrate and adjust to proper gas concentration (no more than 25%) with the used refrigerant.

The fluid used in leak detection is applicable to most refrigerants. But do not use chloride solvents to prevent the reaction between chlorine and refrigerants and the corrosion of copper pipeline.

If you suspect a leak, then remove all the fire from the scene or put out the fire.

If the location of the leak needs to be welded, then all refrigerants need to be recovered, or, isolate all refrigerants away from the leak site (using cut-off valve). Before and during the welding, use OFN to purify the entire system.

Removal and Vacuum Pumping

1. Make sure there is no ignited fire source near the outlet of the vacuum pump and the ventilation is well.

2. Allow the maintenance and other operations of the refrigeration circuit should be carried out according to the general procedure, but the following best operations that the flammability is already taken into consideration are the key. You should follow the following procedures:

- Remove the refrigerant.
- Decontaminate the pipeline by inert gases.
- Evacuation.
- Decontaminate the pipeline by inert gases again.
- Cut or weld the pipeline.

3. The refrigerant should be returned to the appropriate storage tank. The system should be blown with oxygen free nitrogen to ensure safety. This process may need to be repeated for several times. This operation shall not be carried out using compressed air or oxygen.

4. Through blowing process, the system is charged into the anaerobic nitrogen to reach the working pressure under the vacuum state, then the oxygen free nitrogen is emitted to the atmosphere, and in the end, vacuumize the system. Repeat this process until all refrigerants in the system is cleared. After the final charging of the anaerobic nitrogen, discharge the gas into the atmosphere pressure, and then the system can be welded. This operation is necessary for welding the pipeline.

Procedures of Charging Refrigerants

As a supplement to the general procedure, the following requirements need to be added:

- Make sure that there is no contamination among different refrigerants when using a refrigerant charging device. The pipeline for charging refrigerants should be as short as possible to reduce the residual of refrigerants in it.
- Storage tanks should remain vertically up.
- Make sure the grounding solutions are already taken before the refrigeration system is charged with refrigerants.
- After finishing the charging (or when it is not yet finished), label the mark on the system.
- Be careful not to overcharge refrigerants.

Scrap and Recovery

Scrap:

Before this procedure, the technical personnel shall be thoroughly familiar with the equipment and all its features, and make a recommended practice for refrigerant safe recovery. For recycling the refrigerant, shall analyze the refrigerant and oil samples before operation. Ensure the required power before the test.

1. Be familiar with the equipment and operation.
2. Disconnect power supply.
3. Before carrying out this process, you have to make sure:
 - If necessary, mechanical equipment operation should facilitate the operation of the refrigerant tank.
 - All personal protective equipment is effective and can be used correctly.
 - The whole recovery process should be carried out under the guidance of qualified personnel.
 - The recovering of equipment and storage tank should comply with the relevant national standards.
4. If possible, the refrigerating system should be vacuumized.
5. If the vacuum state can't be reached, you should extract the refrigerant in each part of the system from many places.
6. Before the start of the recovery, you should ensure that the capacity of the storage tank is sufficient.
7. Start and operate the recovery equipment according to the manufacturer's instructions.

Maintenance Notice

8. Don't fill the tank to its full capacity (the liquid injection volume does not exceed 80% of the tank volume).
9. Even the duration is short, it must not exceed the maximum working pressure of the tank.
10. After the completion of the tank filling and the end of the operation process, you should make sure that the tanks and equipment should be removed quickly and all closing valves in the equipment are closed.
11. The recovered refrigerants are not allowed to be injected into another system before being purified and tested.

Note: The identification should be made after the appliance is scrapped and refrigerants are evacuated. The identification should contain the date and endorsement. Make sure the identification on the appliance can reflect the flammable refrigerants contained in this appliance.

Recovery:

1. The clearance of refrigerants in the system is required when repairing or scrapping the appliance. It is recommended to completely remove the refrigerant.
2. Only a special refrigerant tank can be used when loading the refrigerant into the storage tank. Make sure the capacity of the tank is appropriate to the refrigerant injection quantity in the entire system. All tanks intended to be used for the recovery of refrigerants should have a refrigerant identification (i.e. refrigerant recovery tank). Storage tanks should be equipped with pressure relief valves and globe valves and they should be in a good condition. If possible, empty tanks should be evacuated and maintained at room temperature before use.
3. The recovery equipment should be kept in a good working condition and equipped with equipment operating instructions for easy access. The equipment should be suitable for the recovery of R290 refrigerants. Besides, there should be a qualified weighting apparatus which can be normally used. The hose should be linked with detachable connection joint of zero leakage rate and be kept in a good condition.
Before using the recovery equipment, check if it is in a good condition and if it gets perfect maintenance. Check if all electrical components are sealed to prevent the leakage of the refrigerant and the fire caused by it. If you have any question, please consult the manufacturer.
4. The recovered refrigerant shall be loaded in the appropriate storage tanks, attached with a transporting instruction, and returned to the refrigerant manufacturer. Don't mix refrigerant in recovery equipment, especially a storage tank.
5. The space loading R290 refrigeration can't be enclosed in the process of transportation. Take anti electrostatic measures if necessary in transportation. In the process of transport, loading and unloading, necessary protective measures must be taken to protect the air conditioner to ensure that the air conditioner is not damaged.
6. When removing the compressor or clearing the compressor oil, make sure the compressor is pumped to an appropriate level to ensure that there is no residual R290 refrigerants in the lubricating oil. The vacuum pumping should be carried out before the compressor is returned to the supplier. Ensure the safety when discharging oil from the system.